



TRIGO S

Silla manual activa plegable
con reposapiés fijos
multi-ajustable
con gran rango de opciones



		P.V.P.	
S = Standard O = opción sin coste extra □ = opción con coste extra		1.800,00 €	

ESTRUCTURA

Ancho de asiento (asiento ajustable en tensión)

	Chasis cerrado 70° (ángulo del reposapiés)	<input type="radio"/>	-	
	Chasis cerrado 80° (ángulo del reposapiés) INCOMPATIBLE CON RUEDA DELANTERA DE 6"	<input type="radio"/>	-	
	Chasis cerrado 90° (ángulo del reposapiés) INCOMPATIBLE CON RUEDA DELANTERA DE 6"	<input type="radio"/>	-	

ASIENTO

Ancho (cm)	Profundidad (cm)											
	32	34	36	38	40	42	44	46	48	50		
30	<input type="radio"/>	<input type="radio"/>	<input type="radio"/>	<input type="radio"/>	<input type="radio"/>	<input type="radio"/>	<input type="radio"/>	<input type="radio"/>	<input type="radio"/>	<input type="radio"/>	-	Cruceta simple peso máx. usuario: 70 kg
32	<input type="radio"/>	<input type="radio"/>	<input type="radio"/>	<input type="radio"/>	<input type="radio"/>	<input type="radio"/>	<input type="radio"/>	<input type="radio"/>	<input type="radio"/>	<input type="radio"/>	-	
34	<input type="radio"/>	<input type="radio"/>	<input type="radio"/>	<input type="radio"/>	<input type="radio"/>	<input type="radio"/>	<input type="radio"/>	<input type="radio"/>	<input type="radio"/>	<input type="radio"/>	-	
36	-	-	<input type="radio"/>	<input type="radio"/>	<input type="radio"/>	<input type="radio"/>	<input type="radio"/>	<input type="radio"/>	<input type="radio"/>	<input type="radio"/>	-	Cruceta 1,5 peso máx. usuario: 130 kg
38	-	-	<input type="radio"/>	<input type="radio"/>	<input type="radio"/>	<input type="radio"/>	<input type="radio"/>	<input type="radio"/>	<input type="radio"/>	<input type="radio"/>	-	
40	-	-	<input type="radio"/>	<input type="radio"/>	<input type="radio"/>	<input type="radio"/>	<input type="radio"/>	<input type="radio"/>	<input type="radio"/>	<input type="radio"/>	-	
42	-	-	<input type="radio"/>	<input type="radio"/>	<input type="radio"/>	<input type="radio"/>	<input type="radio"/>	<input type="radio"/>	<input type="radio"/>	<input type="radio"/>	-	Doble cruceta peso máx. usuario: 130 kg
44	-	-	<input type="radio"/>	<input type="radio"/>	<input type="radio"/>	<input type="radio"/>	<input type="radio"/>	<input type="radio"/>	<input type="radio"/>	<input type="radio"/>	-	
46	-	-	<input type="radio"/>	<input type="radio"/>	<input type="radio"/>	<input type="radio"/>	<input type="radio"/>	<input type="radio"/>	<input type="radio"/>	<input type="radio"/>	-	
48	-	-	<input type="radio"/>	<input type="radio"/>	<input type="radio"/>	<input type="radio"/>	<input type="radio"/>	<input type="radio"/>	<input type="radio"/>	<input type="radio"/>	-	
50	-	-	<input type="radio"/>	<input type="radio"/>	<input type="radio"/>	<input type="radio"/>	<input type="radio"/>	<input type="radio"/>	<input type="radio"/>	<input type="radio"/>	-	

mínimo ancho total con protectores estándar y 0° caída: Ancho asiento + 16 cm

ALTURA DELANTERA ASIENTO (en mm)

	380	390	400	410	420	430	440	450	460	470	480	490	500	510		
rueda 3"	<input type="radio"/>	<input type="radio"/>	<input type="radio"/>	<input type="radio"/>	<input type="radio"/>	<input type="radio"/>	<input type="radio"/>	<input type="radio"/>	<input type="radio"/>	<input type="radio"/>	<input type="radio"/>	<input type="radio"/>	<input type="radio"/>	<input type="radio"/>	-	
rueda 4"		<input type="radio"/>	<input type="radio"/>	<input type="radio"/>	<input type="radio"/>	<input type="radio"/>	<input type="radio"/>	<input type="radio"/>	<input type="radio"/>	<input type="radio"/>	<input type="radio"/>	<input type="radio"/>	<input type="radio"/>	<input type="radio"/>	-	
rueda 5"			<input type="radio"/>	<input type="radio"/>	<input type="radio"/>	<input type="radio"/>	<input type="radio"/>	<input type="radio"/>	<input type="radio"/>	<input type="radio"/>	<input type="radio"/>	<input type="radio"/>	<input type="radio"/>	<input type="radio"/>	-	
rueda 6"				<input type="radio"/>	<input type="radio"/>	<input type="radio"/>	<input type="radio"/>	<input type="radio"/>	<input type="radio"/>	<input type="radio"/>	<input type="radio"/>	<input type="radio"/>	<input type="radio"/>	<input type="radio"/>	-	

ALTURA TRASERA ASIENTO (en mm)

	315	325	335	345	355	365	375	385	395	405	415	425	435	445	455	465	475	485	495	505	515			
rueda 18"	<input type="radio"/>	<input type="radio"/>	<input type="radio"/>	<input type="radio"/>	<input type="radio"/>	<input type="radio"/>	<input type="radio"/>	<input type="radio"/>	<input type="radio"/>	<input type="radio"/>	<input type="radio"/>	<input type="radio"/>	<input type="radio"/>	<input type="radio"/>	<input type="radio"/>	<input type="radio"/>	<input type="radio"/>	<input type="radio"/>	<input type="radio"/>	<input type="radio"/>	<input type="radio"/>	<input type="radio"/>	-	
rueda 20"			<input type="radio"/>	<input type="radio"/>	<input type="radio"/>	<input type="radio"/>	<input type="radio"/>	<input type="radio"/>	<input type="radio"/>	<input type="radio"/>	<input type="radio"/>	<input type="radio"/>	<input type="radio"/>	<input type="radio"/>	<input type="radio"/>	<input type="radio"/>	<input type="radio"/>	<input type="radio"/>	<input type="radio"/>	<input type="radio"/>	<input type="radio"/>	<input type="radio"/>	-	
rueda 22"				<input type="radio"/>	<input type="radio"/>	<input type="radio"/>	<input type="radio"/>	<input type="radio"/>	<input type="radio"/>	<input type="radio"/>	<input type="radio"/>	<input type="radio"/>	<input type="radio"/>	<input type="radio"/>	<input type="radio"/>	<input type="radio"/>	<input type="radio"/>	<input type="radio"/>	<input type="radio"/>	<input type="radio"/>	<input type="radio"/>	<input type="radio"/>	-	
rueda 24"					<input type="radio"/>	<input type="radio"/>	<input type="radio"/>	<input type="radio"/>	<input type="radio"/>	<input type="radio"/>	<input type="radio"/>	<input type="radio"/>	<input type="radio"/>	<input type="radio"/>	<input type="radio"/>	<input type="radio"/>	<input type="radio"/>	<input type="radio"/>	<input type="radio"/>	<input type="radio"/>	<input type="radio"/>	<input type="radio"/>	-	
rueda 26"						<input type="radio"/>	<input type="radio"/>	<input type="radio"/>	<input type="radio"/>	<input type="radio"/>	<input type="radio"/>	<input type="radio"/>	<input type="radio"/>	<input type="radio"/>	<input type="radio"/>	<input type="radio"/>	<input type="radio"/>	<input type="radio"/>	<input type="radio"/>	<input type="radio"/>	<input type="radio"/>	<input type="radio"/>	-	



PROTECTORES

B82S fijo	Protector de ropa fijo - aluminio	○	-	img 001
B82-C fijo	Protector de ropa fijo - carbono	□	380,00 €	img 001
B82 fijo	Protector de ropa antisalpicaduras fijo - aluminio	□	54,00 €	img 002
Bi5	Reposabrazos ajustable en altura	□	75,00 €	img 003
TUBE	Reposabrazos tubular (abatible) <i>incompatible con respaldo regulable o plegable</i>	□	90,00 €	img 004
B82S-A	Protector de ropa extraíble - aluminio	□	90,00 €	img 005
B82S-C	Protector de ropa extraíble - carbono	□	340,00 €	img 005
B82SL-A	Protector de ropa extraíble LARGO - aluminio	□	105,00 €	img 006
B82-A	Protector de ropa antisalpicaduras extraíble - aluminio	□	120,00 €	img 007
B82L-A	Protector de ropa antisalpicaduras extraíble LARGO - aluminio	□	135,00 €	img 008
B82-C	Protector de ropa antisalpicaduras extraíble - carbono	□	380,00 €	img 009

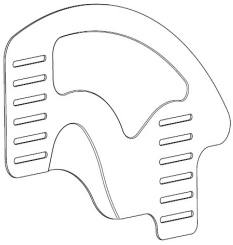

img 001

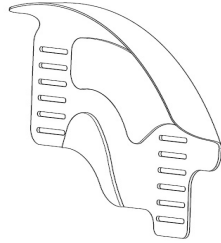

img 002

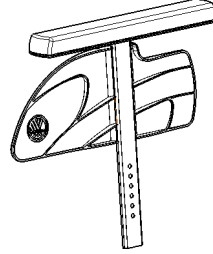

img 003

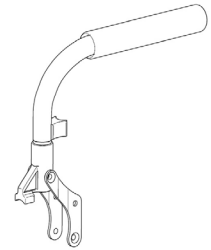

img 004

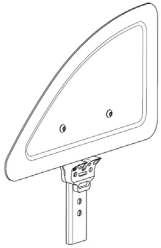

img 005

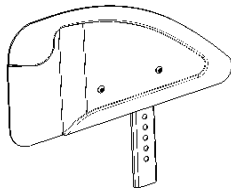

img 006

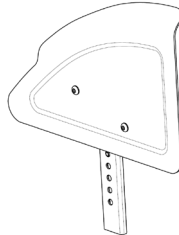

img 007

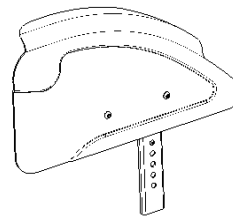

img 008

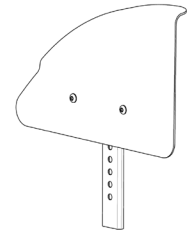

img 009

REPOSAPIÉS

	Monoblock de aluminio, plegable	○	-	img 011
	Moloblock de aluminio, elevado	□	105,00 €	img 012
	Monoblock de carbono	□	315,00 €	img 013
	Invertido (para extremidades más cortas)	□	195,00 €	img 014
	Monoblock abatible	□	50,00 €	img 015
	Paletas reposapiés independientes	□	50,00 €	img 016

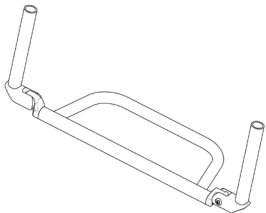

img 011

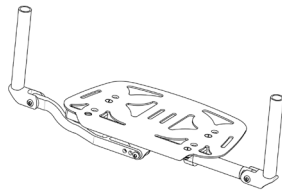

img 012

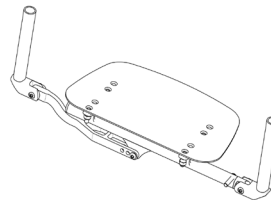

img 013

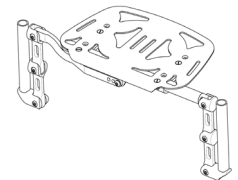

img 014

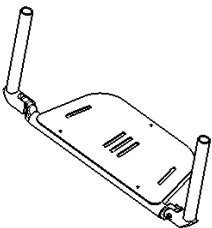

img 015

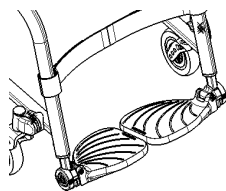

img 016



Longitud de pierna (LLL)	distancia entre hueco poplíteo y arco plantal		
22 cm		<input type="radio"/>	
24 cm		<input type="radio"/>	
26 cm		<input type="radio"/>	
28 cm		<input type="radio"/>	
30 cm		<input type="radio"/>	
32 cm		<input type="radio"/>	
34 cm		<input type="radio"/>	
36 cm		<input type="radio"/>	
38 cm		<input type="radio"/>	
40 cm		<input type="radio"/>	
42 cm		<input type="radio"/>	
44 cm		<input type="radio"/>	
46 cm		<input type="radio"/>	
48 cm		<input type="radio"/>	

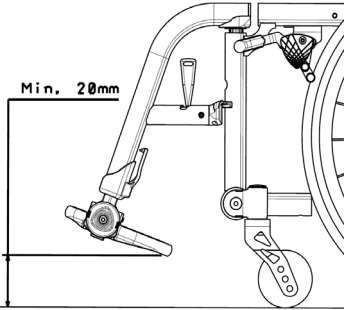

Min. 20mm

La longitud de pierna debe ser al menos 20mm menos que la altura delantera de asiento escogida

COLORES (chasis)

Parte delantera		mate brillo			
C4	Rojo	<input type="radio"/>	<input type="radio"/>	-	
C5	Negro	<input type="radio"/>	<input type="radio"/>	-	
C8	Amarillo	<input type="radio"/>	<input type="radio"/>	-	
C29	Plateado	<input type="radio"/>	<input type="radio"/>	-	
C53	Naranja	<input type="radio"/>	<input type="radio"/>	-	
C55	Inox	<input type="radio"/>	<input type="radio"/>	-	
C56	Azul metálico	<input type="radio"/>	<input type="radio"/>	-	
C59	Champagne	<input type="radio"/>	<input type="radio"/>	-	
C71	Azul abisal metálico	<input type="radio"/>	<input type="radio"/>	-	
C72	Rojo cereza metálico	<input type="radio"/>	<input type="radio"/>	-	
C73	Verde metálico	<input type="radio"/>	<input type="radio"/>	-	
C76	Blanco	<input type="radio"/>	<input type="radio"/>	-	
C79	Azul celeste	<input type="radio"/>	<input type="radio"/>	-	
C85	Verde brillante	<input type="radio"/>	<input type="radio"/>	-	
C87	Calabaza	<input type="radio"/>	<input type="radio"/>	-	
C88	Oro	<input type="radio"/>	<input type="radio"/>	-	
C89	Cobre	<input type="radio"/>	<input type="radio"/>	-	
	Color personalizado	<input type="checkbox"/>	<input type="checkbox"/>	225,00 €	
Parte trasera					
	Negro mate	<input type="checkbox"/>	<input type="checkbox"/>	-	
	Color personalizado	<input type="checkbox"/>	<input type="checkbox"/>	225,00 €	

ASIENTO

	Nylon lona fija	<input type="checkbox"/>	<input type="checkbox"/>	-	cojín no incluido
	Nylon ajustable en tensión	<input type="radio"/>	<input type="radio"/>	-	cojín no incluido
	Cojín de espuma 5 cm	<input type="checkbox"/>	<input type="checkbox"/>	60,00 €	
	Cojín de 5cm con capa viscolástica	<input type="checkbox"/>	<input type="checkbox"/>	120,00 €	
B24D	Cojín de 6 cm partido para plegado	<input type="checkbox"/>	<input type="checkbox"/>		

Cojines VICAIR

	Cojín VICAIR ADJUSTER O2 6 cm	<input type="checkbox"/>	<input type="checkbox"/>	535,00 €	
	Cojín VICAIR ADJUSTER O2 10 cm	<input type="checkbox"/>	<input type="checkbox"/>	535,00 €	
	Cojín VICAIR VECTOR O2 6 cm	<input type="checkbox"/>	<input type="checkbox"/>	599,00 €	
	Cojín VICAIR VECTOR O2 10 cm	<input type="checkbox"/>	<input type="checkbox"/>	599,00 €	
	Cojín VICAIR ACTIVE O2 6 cm	<input type="checkbox"/>	<input type="checkbox"/>	575,00 €	
	Cojín VICAIR ACTIVE O2 10 cm	<input type="checkbox"/>	<input type="checkbox"/>	575,00 €	

O₂
LAVABLES A MÁQUINA
100% TRANSPIRABLE



ADJUSTER O2



VECTOR O2

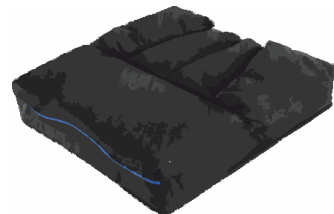

ACTIVE O2



RESPALDO

Estructura					
	Respaldo fijo		○	-	img 021
	Respaldo reclinable (82° - 102°) ajuste mediante botón, ángulo standard: 90°	No disponible para anchos 30-34 cm Consulta la tabla de compatibilidades	□	210,00 €	img 022
	Respaldo reclinable & plegable (82° - 102°) ajuste mediante botón, ángulo standard: 90°	No disponible para anchos 30-34 cm Consulta la tabla de compatibilidades	□	252,00 €	img 023

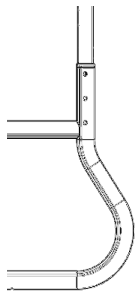

img 021

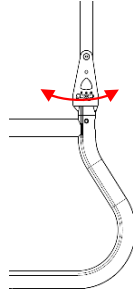

img 022

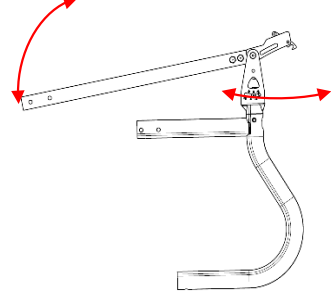

img 023

Tapizado					
	Nylon - ajustable en tensión con reflectantes traseros		○	-	
	Net - ajustable en tensión con reflectantes traseros		○	-	
	3D - ajustable en tensión con reflectantes traseros		○	-	
	Bolsillo trasero		□	30,00 €	

Altura respaldo

	Tipo de Puños de empuje (ver abajo)	no PH	PH 01	PH 02	PH 03	PH 04	PH 05	PH 06			● : compatible Δ : compatible sólo con respaldo fijo - : incompatible	
Altura fija	25 cm	Δ	Δ	Δ	Δ	-	Δ	Δ	○	-		
	27 cm	Δ	Δ	Δ	Δ	-	Δ	Δ	○	-		
	29 cm	Δ	Δ	Δ	Δ	-	Δ	Δ	○	-		
	31 cm	Δ	Δ	Δ	Δ	-	Δ	Δ	○	-		
	33 cm	Δ	Δ	Δ	Δ	-	Δ	Δ	○	-		
	35 cm	●	●	●	●	-	●	●	○	-		
	37 cm	●	●	●	●	-	●	●	○	-		
	39 cm	●	●	●	●	Δ	●	●	○	-		
	41 cm	●	●	●	●	Δ	●	●	○	-		
	43 cm	●	●	●	●	Δ	●	●	○	-		
	45 cm	●	●	●	●	Δ	●	●	○	-		
	47 cm	●	●	●	●	Δ	●	●	○	-		
49 cm	●	●	●	●	Δ	●	●	○	-			
51 cm	●	●	●	●	Δ	●	●	○	-			
Ajustable en altura (3 tramos)	25 - 27,5 - 30 cm	Δ	Δ	Δ	-	-	Δ	-	□		30,00 €	
	30 - 32,5 - 35 cm	Δ	●	●	Δ	-	Δ	-	□		30,00 €	
	35 - 37,5 - 40 cm	●	●	●	●	-	●	-	□		30,00 €	
	40 - 42,5 - 45 cm	●	●	●	●	-	●	-	□		30,00 €	
	45 - 47,5 - 50 cm	●	●	●	●	-	●	-	□		30,00 €	

Puños de empuje					
no PH	Sin puños de empuje		○	-	no PH
PH 01	Puños fijos (12cm)		□	15,00 €	PH 01
PH 02	Puños fijos cortos (8cm)		□	15,00 €	PH 02
PH 03	Puños plegables		□	150,00 €	PH 03
PH 04	Ajustables en altura telescópicos		□	45,00 €	PH 04
PH 05	Ajustables en altura con brida		□	150,00 €	PH 05
PH 06	Ajustables en altura con brida y plegables		□	240,00 €	PH 06

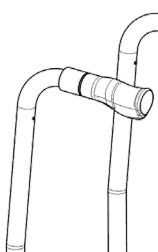

PH 01

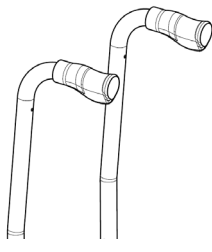

PH 02



PH 03

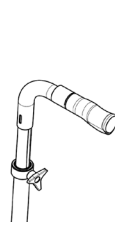

PH 04

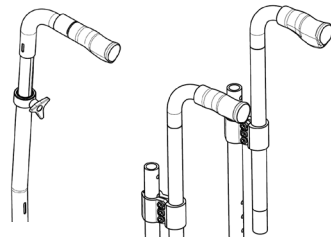

PH 05

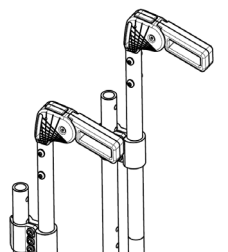

PH 06



RUEDAS

Ruedas delanteras

diámetro	3"	4"	5"	6"	SELECCIONAR MISMO DIÁMETRO QUE EL ESCOGIDO PARA LA ALTURA DE ASIENTO DELANTERA		
standard negro	<input type="radio"/>	<input type="radio"/>	<input type="radio"/>	<input type="radio"/>	6" es incompatible con chasis 80° y 90°	-	img 031
transparente	<input type="radio"/>	<input type="radio"/>	<input type="radio"/>			-	img 032
alu - plata	<input type="checkbox"/>	<input type="checkbox"/>	<input type="checkbox"/>			60,00 €	img 033
alu - rojo	<input type="checkbox"/>	<input type="checkbox"/>	<input type="checkbox"/>			60,00 €	img 033
alu - azul	<input type="checkbox"/>	<input type="checkbox"/>	<input type="checkbox"/>			60,00 €	img 033
carbono		<input type="checkbox"/>	<input type="checkbox"/>			105,00 €	img 034
LED		<input type="checkbox"/>	<input type="checkbox"/>			60,00 €	img 035



img 031



img 032



img 033



img 034



img 035

Ruedas traseras

18"	Estándar, rueda 18" con cubiertas Schwalbe Marathon Racer	<input type="checkbox"/>	210,00 €	img 041 + img 048	
20"	De diseño, rueda ligera 20" , radial, cubiertas Schwalbe Right Run negras	<input type="radio"/>	-	img 042 + img 046	
22"	De diseño, rueda ligera 22" , radial, cubiertas Schwalbe Right Run negras	<input type="radio"/>	-	img 042 + img 046	
24"	De diseño, rueda ligera 24" , radial, cubiertas Schwalbe Right Run negras	<input type="radio"/>	-	img 042 + img 046	
	De diseño, rueda ligera 24" , radial, cubiertas Schwalbe Marathon Plus	<input type="checkbox"/>	120,00 €	img 042 + img 047	
	Spirit 24" con buje de aluminio, radial, cubiertas Schwalbe Right Run negras	<input type="checkbox"/>	600,00 €	img 043 + img 046	
	Spirit 24" con buje de aluminio, radial, cubiertas Schwalbe Marathon Plus	<input type="checkbox"/>	650,00 €	img 043 + img 047	
	Spirit 24" buje rojo de aluminio, radial, cubiertas Schwalbe Right Run negras	<input type="checkbox"/>	600,00 €	img 043 + img 046	
	Spirit 24" buje rojo de aluminio, radial, cubiertas Schwalbe Marathon Plus	<input type="checkbox"/>	650,00 €	img 043 + img 047	
	Spirit 24" buje azul de aluminio, radial, cubiertas Schwalbe Right Run negras	<input type="checkbox"/>	600,00 €	img 043 + img 046	
	Spirit 24" buje azul de aluminio, radial, cubiertas Schwalbe Marathon Plus	<input type="checkbox"/>	650,00 €	img 043 + img 047	
	26"	De diseño, rueda ligera 26" , radial, cubiertas Schwalbe Right Run negras	<input type="checkbox"/>	75,00 €	img 042 + img 046
		De diseño, rueda ligera 26" , radial, cubiertas Schwalbe Marathon Plus	<input type="checkbox"/>	180,00 €	img 042 + img 046
	Off road 24" (juego extra de ruedas)	<input type="checkbox"/>	500,00 €	img 044	
HEM2	Kit doble aro - rueda 24 x 1 3/8"	<input type="checkbox"/>	350,00 €		



img 046:
Right Run



img 047:
Marathon Plus



img 048:
Marathon Racer



img 041



img 042





img 043



img 044

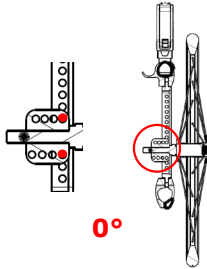
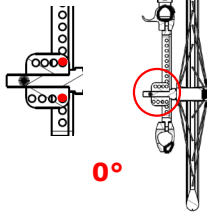
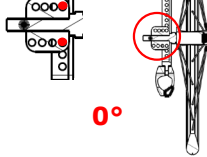

Caída (modificable por el usuario)				
	0°		<input type="radio"/>	-
	2°		<input type="radio"/>	-
	4°		<input type="radio"/>	-
	6°		<input type="radio"/>	-

Frenos				
	Freno de tiro (bloqueo tirando hacia atrás)	<input type="radio"/>	-	img F01
	Freno de empuje (bloqueo empujando hacia adelante)	<input type="radio"/>	-	img F02
	Freno deportivo	<input type="checkbox"/>	75,00 €	img F03
	Frenos de tambor (sólo con camber 0°) - ruedas 24 x 1 3/8" macizas grises	<input type="checkbox"/>	160,00 €	img F04
B40	Extensión de palanca de freno	<input type="checkbox"/>	30,00 €	img F05

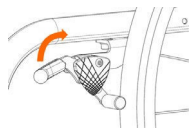

img F01



img F02



img F03

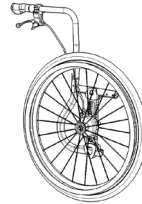

img F04



img F05

OPCIONES

B31L	Porta-bastones izquierdo	<input type="checkbox"/>	30,00 €	img 051
B31R	Porta-bastones derecho	<input type="checkbox"/>	30,00 €	img 051
B78R	Rueda anti-vuelco derecha	<input type="checkbox"/>	60,00 €	img 052
B78L	Rueda anti-vuelco izquierda	<input type="checkbox"/>	60,00 €	img 052
B86	Ruedas tránsito	<input type="checkbox"/>	120,00 €	img 053
B90	Barra estabilizadora respaldo	<input type="checkbox"/>	30,00 €	img 054
L04 L	Control lateral IZQUIERDO	<input type="checkbox"/>	350,00 €	img 055
L04S L	Control lateral IZQUIERDO - PEQUEÑO	<input type="checkbox"/>	285,00 €	img 056
L04 R	Control lateral DERECHO	<input type="checkbox"/>	350,00 €	img 055
L04S R	Control lateral DERECHO - PEQUEÑO	<input type="checkbox"/>	285,00 €	img 056
B33	Cubre-aros de gel	<input type="checkbox"/>	120,00 €	img 057
	Cubre-radios	<input type="checkbox"/>	90,00 €	img 058
	Cubre-radios - PLANETA AZUL	<input type="checkbox"/>	160,00 €	img 059
	Cubre-radios - JUNGLA	<input type="checkbox"/>	160,00 €	img 060
	Cubre-radios - TRIGO 1	<input type="checkbox"/>	160,00 €	img 061
	Cubre-radios - TRIGO 2	<input type="checkbox"/>	160,00 €	img 062
V10	Cubretubo/protector Neopreno	<input type="checkbox"/>	75,00 €	img 063

incompatible con Ruedas tránsito
incompatible con Ruedas tránsito
Incompatible con anti-vuelco
Sólo compatible con respaldo de altura fija
incompatibles con respaldo ajustable en altura o respaldo plegable

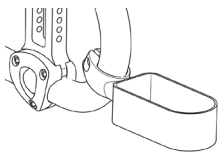

img 051

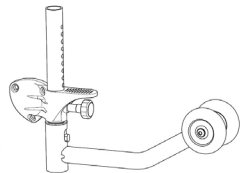

img 052

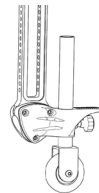

img 053

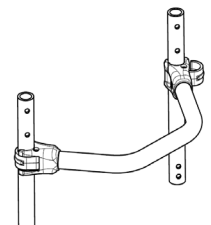

img 054

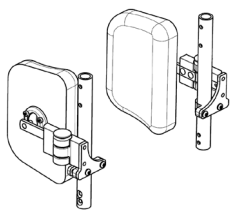

img 055

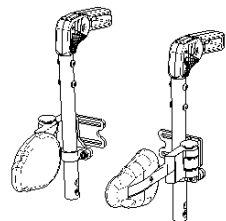

img 056



img 057

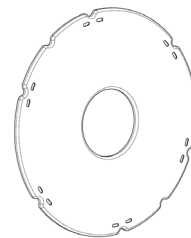

img 058



img 059





img 060



img 061

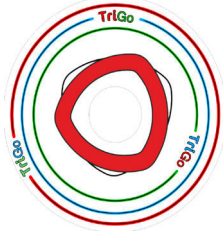

img 062



img 063

